



European  
Commission

A large, light blue circular graphic with three white arrows forming a clockwise cycle, centered over the text.

# Circular Economy Principles for Buildings Design







## Table of content

|  |           |
|--|-----------|
| Table of content   | 2         |
| List of contributing stakeholders  | 3         |
| List of acronyms   | 4         |
| <b>1 Introduction</b>  | <b>5</b>  |
| <b>2 General principles</b>  | <b>8</b>  |
| <b>3 Principles by target group</b>  | <b>10</b> |
| 3.1 Target group 1: Building users, facility managers and owners           | 10        |
| 3.2 Target group 2: Design teams (engineering & architecture of buildings) | 11        |
| 3.3 Target group 3: Contractors and builders                               | 12        |
| 3.4 Target group 4: Manufacturers of construction products                 | 13        |
| 3.5 Target group 5: Deconstruction and demolition teams                    | 14        |
| 3.6 Target group 6: Investors, developers and insurance providers          | 15        |
| 3.7 Target group 7: Government / Regulators / Local authorities            | 15        |
| <b>Annex 1 – References</b>  | <b>19</b> |
| <b>Annex 2 – Terms and definitions</b>                                     | <b>20</b> |



## List of contributing stakeholders

Architects' Council of Europe (ACE)  
Benelux Secretariaat-Generaal  
Bruxelles Environnement / Leefmilieu Brussel  
Cembureau - European Cement Association  
CEN/TC350 Sustainability of Construction Works  
Cerase-Unie - European Ceramic industry Association  
Construction Products Europe (CPE)  
Dutch Ministry of the Interior and Kingdom Relations  
European Aggregates Association (UEPG)  
European Aluminium  
European Builders Confederation (EBC)  
European Confederation of Woodworking Industries (CEI-BOIS)  
European Construction Industry Federation (FIEC)  
European Demolition Association (EDA)  
European Federation for Construction Chemicals (EFCC)  
European Federation of Waste Management and Environmental Services (FEAD)  
European Insulation Manufacturers Association (EURIMA)  
European Manufacturers Association for Plaster and Plasterboard Products (Eurogypsum)  
European Property Federation (EPF)  
Ministère de la Transition écologique et solidaire  
Housing Europe - European Federation of Public, Cooperative & Social Housing  
International Recycling Federation / Fédération Internationale du Recyclage (FIR)  
International Union of Property Owners (UIPI)  
Lafarge Holcim  
Maltese Ministry for Transport, Infrastructure and Projects  
Nobatek/ INEF4 - Institut national pour la Transition Energétique du Bâtiment  
Norwegian Building Authority  
Plastics Europe  
PU Europe - European voice of the polyurethane (PUR / PIR) insulation industry  
Public Waste Agency of Flanders (OVAM)  
Rockwool Group  
Royal Institute of Chartered Surveyors (RICS)  
Saint-Gobain  
Swedish National Board of Housing, Building and Planning  
The European Steel Association (Eurofer)



## List of acronyms

|       |  |
|-------|--|
| BAMB  | Buildings As Material Banks                    |
| BIM   | Building Information Modelling                 |
| CDW   | Construction and Demolition Waste              |
| DfD   | Design for Deconstruction                      |
| DfD/A | Design for Disassembly and Adaptability        |
| DGNB  | German Sustainable Building Council            |
| EN    | European Standard                              |
| EPR   | Extended producer responsibility               |
| EU    | European Union                                 |
| GPP   | Green Public Procurement                       |
| ISO   | International Organization for Standardization |
| IT    | Information technology                         |
| LCA   | Life Cycle Assessment                          |
| LCC   | Life Cycle Costing                             |
| PET   | Polyethylene terephthalate                     |
| RBD   | Reversible Building Design protocol/tool       |
| SVHC  | Substances of Very High Concern                |
| CPR   | EU Construction Products Regulation            |



# 1 Introduction

## *Background*

More than at any time before, we need to apply circular economy and resource efficiency principles to buildings to reduce resource use in the future. The European Commission has reaffirmed this message by the European Green Deal<sup>1</sup>. However, it is far from easy to implement concepts of resource efficiency and the circular economy to buildings. The actors involved are facing several existing or potential dilemmas: structural resistance versus easy to disassemble, longevity versus flexibility, simple versus composite products, renovations versus new-build, etc.

Within the context of the Construction 2020 initiative,<sup>2</sup> the Thematic Group 3 on “Sustainable use of natural resources” – bringing together a diverse group of relevant stakeholders from the European Commission, Member States and the construction value chain – has taken several steps towards a circular economy approach and increased resource efficiency in the building sector. For example, Thematic Group 3 developed an EU Construction & Demolition Waste Protocol and Guidelines – published in 2016 and widely promoted since.<sup>3</sup>

Building on the above actions, Thematic Group 3 started a new initiative, following the announcement of the Clean Energy for All Package.<sup>4</sup> The EU Construction and Demolition Waste Protocol and Guidelines for pre-demolition waste audits<sup>5</sup> focused on the reuse and recycling of this particular waste stream. In contrast, the focus of the current initiative is to present a set of principles for the sustainable design of buildings with the aim to generate less construction and demolition waste as well as facilitate the reuse and recycling of construction materials, products and building elements, and help reduce the environmental impacts and life cycle costs of the building.

As part of the preparation of this document, Thematic Group 3 has held several meetings and exchanges in 2017, 2018 and 2019 to deepen the insights into this complex matter and to provide room for a balanced representation of views. This document builds heavily on the insights and expertise shared by participating stakeholders. The document has benefited from various rounds of exchange before evolving into this final version.

## *Aims of this document*

To inform and support actors along the construction value chain, this document provides principles for circular design of buildings. Behind these principles lie a vast amount of knowledge and information. The document is aligned with the launch of Level(s), a voluntary reporting framework to improve the sustainability of buildings.<sup>6</sup> In particular, this document contributes to Level(s) Macro-objective 2: Resource efficient and circular material life

---

<sup>1</sup> COM (2019) 640 final, <https://eur-lex.europa.eu/legal-content/EN/TXT/?qid=1579087430180&uri=CELEX:52019DC0640>

<sup>2</sup> In 2012, the Commission published a Communication Strategy for the sustainable competitiveness of the construction sector and its enterprises. <https://eur-lex.europa.eu/legal-content/EN/TXT/?uri=CELEX:52012DC0433>. The document is a part of the Europe 2020 initiative. It focuses on the promotion of favourable market conditions for sustainable growth in the construction sector (COM2012/0433).

<sup>3</sup> [https://ec.europa.eu/growth/content/eu-construction-and-demolition-waste-protocol-0\\_en](https://ec.europa.eu/growth/content/eu-construction-and-demolition-waste-protocol-0_en)

<sup>4</sup> Annex: Clean Energy in Buildings, [https://eur-lex.europa.eu/resource.html?uri=cellar:fa6ea15b-b7b0-11e6-9e3c-01aa75ed71a1.0001.02/DOC\\_2&format=PDF](https://eur-lex.europa.eu/resource.html?uri=cellar:fa6ea15b-b7b0-11e6-9e3c-01aa75ed71a1.0001.02/DOC_2&format=PDF)

<sup>5</sup> This is the second outcome of Thematic Group 3 as requested by the first Circular Economy Action Plan. It provides a methodology to perform an assessment before demolition and renovation in order to support national authorities in achieving the EU 2020 target for CDW recycling. [file:///C:/Users/parenal/AppData/Local/Packages/Microsoft.MicrosoftEdge\\_8wekyb3d8bbwe/TempState/Downloads/Guidelines%20for%20the%20waste%20audits.pdf](file:///C:/Users/parenal/AppData/Local/Packages/Microsoft.MicrosoftEdge_8wekyb3d8bbwe/TempState/Downloads/Guidelines%20for%20the%20waste%20audits.pdf)

<sup>6</sup> <http://ec.europa.eu/environment/eussd/buildings.htm>



cycles. This macro-objective is about the reduction of waste, the optimisation of material use, and the reduction of environmental impacts of designs and material choices throughout the life cycle.<sup>7</sup>

It is possible to reach this macro-objective through specific objectives or “life cycle tools: scenarios for building lifespan, adaptability and deconstruction”<sup>8</sup>. For the purpose of this document, we have summarised these scenario headings as follows:

1. *Durability*: building and elemental service life planning, encouraging a medium to long term focus on the design life of major building elements, as well as their associated maintenance and replacement cycles;
2. *Adaptability*: to extend the service life of the building as a whole, either by facilitating the continuation of the intended use or through possible future changes in use – with a focus on replacement and refurbishment;
3. *Reduce waste and facilitate high-quality waste management*: facilitate the future circular use of building elements, components and parts, with a focus on producing less waste and on the potential for the reuse, or high-quality recycling of major building elements following deconstruction. This includes efforts along the value chain to promote: 1) the reuse or recycling of resources, (i.e. materials) in a way that most of the material's value is retained and recovered at the end of a building's life span; 2) the component design and the use of different construction methods to influence the recovery for reuse or recycling to avoid down-cycling.

#### *Target audiences for this document*

This document is intended for those involved in the construction industry, including economic operators in the value chain, policy-makers, legal and technical actors. They are organised in 7 target groups:

1. Building users, facility managers and owners;
2. Design teams (engineering & architecture of buildings);
3. Contractors and builders;
4. Manufacturers of construction products;
5. Deconstruction and demolition teams;
6. Investors, developers and insurance providers;
7. Government/ Regulators/ Local authorities.

#### *Structure of this document*

The document is divided in two chapters: Chapter 2 presents general principles and Chapter 3 presents principles relevant to each target group.

---

<sup>7</sup> JRC Technical Reports (2017) “Level(s) – A common EU framework for core sustainability indicators for office and residential buildings”, Parts 1 and 2, p. 33 and further, [https://susproc.jrc.ec.europa.eu/Efficient\\_Buildings/docs/170816\\_Levels\\_EU\\_framework\\_of\\_building\\_indicators\\_Parts.pdf](https://susproc.jrc.ec.europa.eu/Efficient_Buildings/docs/170816_Levels_EU_framework_of_building_indicators_Parts.pdf)

<sup>8</sup> JRC Technical Reports (2017) “Level(s) – A common EU framework for core sustainability indicators for office and residential buildings”, Part 3, p. 69 and further. [https://susproc.jrc.ec.europa.eu/Efficient\\_Buildings/docs/170816\\_Levels\\_EU\\_framework\\_of\\_building\\_indicators.pdf](https://susproc.jrc.ec.europa.eu/Efficient_Buildings/docs/170816_Levels_EU_framework_of_building_indicators.pdf)



**Figure: Scope of the principles – by specific objective and target group**

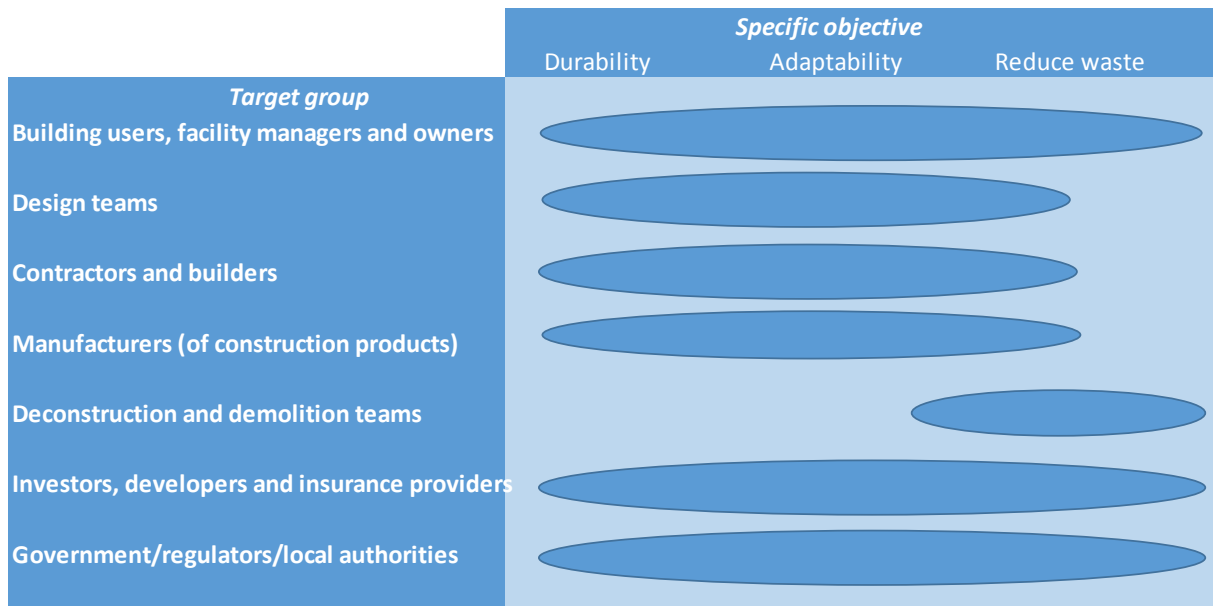

As demonstrated by the figure above, nearly all target groups can contribute to meeting the specific objectives durability, adaptability and reduction of waste (including high-quality recycling). Hence, an integrated approach along the value chain is vital.

In Chapter 3, circular economy principles are presented in sub-sections for each target group. In most sections, the principles are organised by specific objective: durability, adaptability or reduction of waste. The government/regulators/local authorities section is structured according to the Regulate/Realise/Stimulate/Invest objectives.

## 2 General principles

### **How to read these principles:**

**Every principle is presented in bold.**

*Supporting statement(s) just below in italics.*

- Key actions to implement the principle.

### *Overall principles*

#### **A. Design principles of circular economy and sustainable buildings are applicable to all actors along the value chain.**

*Engage with all actors along the value chain, including building users, investors and regulators.*

- Promote understanding and use of existing standards, schemes and examples that enable a more holistic design and adjust business models for including circularity in construction;
- Apply ISO standards for DfD/A (ISO20887) and Levels(s), as well as pre-development audits and other guidance.

#### **B. Sustainable choices must take into account total life cycle costs, financial and non-financial return on investments.**

*Actors along the value chain respond above all to financial incentives – and these need to be tailored to each situation.*

- Look at the financial aspects through a whole life cycle perspective and therefore do a cumulative cost calculation taking into account costs, revenues and residual value;
- Consider scenarios in which estimated costs for new materials, furniture and waste elimination are significantly higher than the actual costs, and in which certain elements could be sold for reuse and/or recycling.

#### **C. Viable business models must exist or be developed for each economic operator in the supply or value chain.**

*A reliable marketplace for used products and materials must exist or be created.*

- A favourable legislative environment, incentives from public decision-makers (e.g. public procurement), innovative and circular businesses as well as financial models, must be put in place to ensure a long term vision and support building owners' decision-making;
- Innovative circular business models such as “take-back” business models or “product as a service” business models can offer interesting solutions for some products and systems.

#### **D. Principles need to be applied taking into account proportionality - benefits should outweigh the costs.**

*It is important to consider the burden and costs for operators to follow these principles.*

- Operators should prioritise those principles which are most relevant and generate the highest benefits and lowest costs;
- Externalities should be taken into account when assessing costs and benefits.

#### **E. Better knowledge is needed about construction techniques to facilitate deconstruction and to enhance durability and adaptability of a building.**

*In all parts of the value chain, workers need to have the right skills and incentives to apply this knowledge and use the appropriate tools.*



- 
- Designers and project managers should ensure safety and consider the feasibility of demolition/renovation for the workers;
  - Allocate specific funds for the upskilling of workers;
  - Integrate deconstruction techniques into apprenticeship schemes.

#### *Durability*

### **F. Durability of buildings depends on better design, improved performance of construction products and information sharing.**

*Structural elements should last as long as the building does, whenever possible. If it is not possible because of intrinsic obsolescence or anticipated change in requirements (e.g. IT infrastructure), they should be reusable, recyclable or dismantlable.*

- Favour construction systems that incorporate circular economy thinking. For instance, enable systems to be easily maintained, repaired and replaced as this will prolong the life cycle of buildings;
- Ask for detailed information from providers and designers on products, materials and the design of the buildings. Conserve, update and share the information so that it can remain valid and relevant during the whole life cycle of the building.

#### *Adaptability*

### **G. Prevent premature building demolition by developing a new design culture.**

- Anticipate changes in requirements;
- Enable adaptations and transformations of the building for better use and reuse, new ways of using it, and prepare for the end-of-life and future lives of the building and its components.

#### *Reduce waste and facilitate high-quality waste management*

### **H. Design products and systems so that they can be easily reused, repaired, recycled or recovered.**

*When recycling, it is preferable that products and systems should be upcycled, too.*

- Make use of easy to dismount elements and products;
- Prescribe in procurement contracts that waste should be separated on site to facilitate recycling;
- Use simple and recyclable products.

## 3 Principles by target group

### 3.1 Target group 1: Building users, facility managers and owners<sup>9</sup>

#### Durability

#### 1. Minimise the total cost of ownership over time.

*Owners and building users have an interest in overall and longer-term horizons.*

- Reduce the total cost per square meter / comparative average;
- Use tools to enhance the building's value.

#### 2. Promote durability during the use phase.

- Provide incentives through performance-based contracts that promote the optimal use of the building.

#### 3. Perform appropriate maintenance of buildings and buildings components to minimise running costs.

*The life cycle of a building can be extended by maintaining and repairing the building while reducing the use of new resources and the production of waste; information and guidelines help achieve proper maintenance and use to meet these aims.*

- Adapt and transform the building while reusing elements it is built of;
- Consider innovative circular business models and elaborate guidelines concerning the elements of fittings (e.g. carpets, kitchens, etc.), in terms of their selection, installation, maintenance, and disposal.

#### Adaptability

#### 4. Minimise the financial cost of use through adequate tools.

*Such tools support ease of maintenance, adaptations, repair, monitoring and running costs. It is important to provide information on maintenance needs. Information on what is possible through reversible building design and how to do it is crucial to inform the users and facility managers of the potential of the building.*

- BIM and building passports can support the transfer of information and apprise the users and maintenance team on how to best use/maintain/repair or adapt the building and its systems and products;
- A user guide for the building and its equipment is useful for owners/users of the building and its equipment.

#### 5. The building should be adapted if it extends the lifetime at reasonable cost.

*Adaptability can improve the response to shifts in market demand (e.g. transforming an unused office building into apartments). Adaptability can also help secure financing: for example, the potential of a second life cycle of a building can ensure cheaper financing and loan insurance.*

- The transformation to a circular approach requires a systemic vision around an integrator of use(s) responsible for animating the design and use of multifunctional, circular, collaborative or even inclusive use of the building with all the actors involved.

#### 6. Promote and maximise the adaptability of buildings from a user's perspective.

*Information and guidelines should help users, owners, and facility managers to make modifications to the building and so have a lower impact on waste generation.*

---

<sup>9</sup> It is important to recognise that incentives for building users, facility managers and owners may differ.



- The possibility to reuse building materials when the use is changed should be explained in an “as-built document”. Changes during use should be registered in some kind of “building logbook”;
- If reversible building design is used, it can support the flexible use and ease of adaptation of space when the purpose and requirements of a building are changed during its lifespan.

#### *Reduce waste and facilitate high-quality waste management*

#### **7. Minimise the use of natural resources during the building’s life.**

*A reusable building parts inventory will inform the users and facility managers both during the life cycle of a building and in the next life cycles.*

- Establish contractual arrangements to return non-used items to providers;
- Use the products/elements to the maximum and, when it is possible, prefer repairing rather than changing them.

### **3.2 Target group 2: Design teams (engineering & architecture of buildings)**

#### **It is essential to have knowledge of circular economy principles to design buildings and materials.**

*Architects and designers should be familiar with design requirements and strategies, the concept of life cycle assessment, the potential to increase the content of recycled materials in products, future reuse potential (product, component and building); (future) recyclability and transformation capacity (reuse potential and reversible building design score).*

- Encourage designers to adopt a life cycle approach when designing new buildings;
- Use existing guides on DfD/A and feedback from previous project examples.

#### **8. Architects and designers need to take into account whole life costs and benefits.**

*The whole life cycle must take into account the operational cost of the building as well as the potential changes to the building’s use. They include environmental and social impacts and benefits, transformation capacity, reuse and recyclability potential.*

#### **9. The project management team needs to be engaged in the process and to consider assessment methods.**

- Establish a number of relevant indicators with regard to the overall circular management system in a building, taking into account those provided by Level(s).

#### *Adaptability*

#### **10. Promote and ensure reversibility and adaptability of the building.**

*The periods between changes of use, renovation or reconstruction are becoming shorter and shorter. Architects and designers should consider several aspects, including climate change adaptation, functional adaptability and wider resilience issues.*

- Before any construction works start, including demolition, an external, independent and neutral expert should provide an assessment and an audit<sup>10</sup>;

**It is essential to design a building with different use scenarios in mind so that it can be easily adapted in the future.**

#### **11. Assess the proposed building design for suitability.**

---

<sup>10</sup> Guidelines for the waste audits before demolition and renovation works of buildings



*The suitability of different solutions, parts and construction products are to be taken into consideration in the context of the specific project. This includes materials, products and systems based on their technical characteristics, their adaptability and life span (technical and economical) and their environmental impact.*

- This will facilitate the maintenance and repair of the building while reducing the use of new resources and the creation of waste;
- It will allow for the adaptation and transformation of the building while reusing the elements it is already built from to the extent possible.

#### *Reduce waste and facilitate high-quality waste management*

### **12. Use materials that are easy to recycle or reuse, and which facilitate high quality waste management.**

- Make use of existing environmental product declarations, product safety data sheets and make sure to comply with the CPR;
- Enable designers to explore possibilities of using products and materials already available within existing buildings.

### **13. Take into account the variety of circular economy aspects when designing the different systems and elements.**

*Such as: the size/volume/weight, etc., of materials to manage in the demolition process; functional decomposition; systemisation; hierarchical relations between elements; base element specifications; assembly sequences; geometry of the connections; type of connections; life cycle co-ordination in assembly/disassembly and the recyclability of materials and reusability of products, and how material choice can influence the quality of waste management.*

## **3.3 Target group 3: Contractors and builders**

### *Durability*

### **14. Use construction techniques that promote the durability of buildings and the resilience of the materials.**

- Simulate different scenarios of durability and compare costs;
- Include the resources needed for resilience to installation error;
- To enhance the building's durability, use construction techniques that facilitate maintenance and repairs to different parts of buildings and building products and systems.

### *Adaptability*

### **15. Use construction techniques that promote the adaptability of buildings.**

*Depending on the frequency of maintenance, repair and transformation needs, it is possible to define several stages of reversibility for various parts of the building, allowing for different construction techniques.*

- Focus on key performance indicators, such as whole life costing and benefits.

#### *Reduce waste and facilitate high-quality waste management*

### **16. For maximum benefits, construction, demolition or renovation need to be planned carefully.** <sup>11</sup>

*This can bring about important cost benefits, as well as environmental and health benefits and carbon savings. Such preparatory activities are particularly crucial for larger buildings.*

---

<sup>11</sup> See also principle 2 from the EU Construction & Demolition Waste Protocol; [https://ec.europa.eu/growth/content/eu-construction-and-demolition-waste-protocol-0\\_en](https://ec.europa.eu/growth/content/eu-construction-and-demolition-waste-protocol-0_en)



- 
- Carry out a pre-demolition audit (or waste management audit) before any renovation or demolition project and for any materials to be re-used or recycled, as well as for hazardous waste.

**17. Facilitate deconstruction by using construction techniques as set out in design guidelines and standards.**

- Use construction techniques which contribute to easy and clean building deconstruction;
- In anticipation, choose techniques/assembly systems of construction products that allow at least selective deconstruction (sorting at source) and at best dismantling;
- Support the uptake of BIM so that the future building deconstruction, including recycling and reuse, is rendered easier and safer.

**18. Give preference to use of recycled, recyclable, reusable and/or reused products.**

- Check the purchase documents, the products datasheet, and the availability of recycled materials in the area.

### 3.4 Target group 4: Manufacturers of construction products

#### *Durability*

**19. Consider the potential durability level for the whole life cycle of the building based on evidence from LCC of the product.**

- Use whole life costing and environmental assessment integrated with supplementary information beyond the building life cycle;
- Use qualitative and resistant products for their environmental and use attributes.

**20. Ecodesign principles should be used and durability assessed.**

*Product standards, if not yet developed, should include durability and a verification system to confirm such durability.*

**21. Solutions should be developed for greater adaptability.**

*For example, in works, prefabrication and modular systems.*

#### *Reduce waste and facilitate high-quality waste management*

**22. Increase products' recycling and recovery potential by providing the necessary information.**

*Knowing what the product consist of is very important with regard to reuse potential and recycling, to avoid, for instance, contamination of an identified material stream with an unidentified one.*

- Ensure good traceability of where the product is manufactured.

**23. Use harmonised materials passports and building passports.**

*Existing Environmental Product Declarations and national tools - to help the manufacturer to understand how the product is used/applied - should be developed and used. This will support the choices to be made during the use of the building, end-of-life, and recovery.*

- Know for what purpose the product has been designed (e.g., repair, reuse, remanufacturing, reconfiguration?);
- Know how the product is implemented/installed in, and connected to, the building and other construction products and systems;
- Keep available information about the technical characteristics of materials and products and promote traceability of the changes and uses of the product during its life cycle.

**24. Minimise the use of natural resources of construction products wherever feasible.**



*It is best to choose reused or recycled materials that provide durability, technical and environmental performance, and that meet the same maintenance requirements and standards of the primary material.*

- Provide information to the users and decision-makers on the reuse, recycling and recovery potential of construction products and materials to encourage a reduction of natural resource depletion;
- Use quality materials and with intrinsic finishing;
- Design by using standard dimensions so to reduce off-cuts.

#### **25. Avoid hazardous substances.**

*This refers to Substances of Very High Concern (SVHC) and other substances, solutions, and material compositions which could hamper reuse or recycling, or curb their use in public and private buildings, wherever feasible, as this will make future reuse/recycling more difficult.*

- Alert the relevant actors about the products used, especially the presence of hazardous substances in the building/construction/structures.

### **3.5 Target group 5: Deconstruction and demolition team <sup>12</sup>**

#### *Reduce waste and facilitate high-quality waste management*

#### **26. Recycling conditions (including infrastructure) and circular value chains and loops must be in place for all potentially recyclable materials.**

*There might be long distances between the demolition site, the recycling facilities, the (re)manufacturing plants and new construction site and therefore call for transport. The value is also dependent on the quantity, i.e. small amounts of waste have less or no value.*

- Regional loops must be developed and include sorting and recycling facilities where inert waste is turned into recycled aggregates and where mixed waste is sorted;
- Consider subsidies/rebates for building materials composed of recycled materials.

#### **27. Make effective use of pre-deconstruction or pre-development audit and appropriate information tools**

<sup>13</sup>

- Identify the resources contained in the building and identify outlets and forms of recovery;
- Ensure selective deconstruction and take full account of state of the art practices;
- Assess construction and demolition materials and waste streams prior to deconstruction or renovation;
- Make use of tools developed (e.g. BIM, materials passports of construction products and systems as well as building passports) to enable rapid and accurate assessments of recovery, reuse and recycling potential of specific products and systems and corresponding value propositions.

#### **28. Tailored dismantling techniques should be applied.**

*The sorting must be made with dismantling; the materials must be separated into batches with a place of destination/treatment according to a "road map" (pre-demolition audit), as accurately as possible, established based on a list of products.*

#### **29. Preliminary sorting should take place on site.**

---

<sup>12</sup> For more principles on construction and deconstruction waste, see the EU's Construction and Demolition Waste Protocol [https://ec.europa.eu/growth/content/eu-construction-and-demolition-waste-protocol-0\\_en](https://ec.europa.eu/growth/content/eu-construction-and-demolition-waste-protocol-0_en)

<sup>13</sup> See [https://ec.europa.eu/growth/content/eu-construction-and-demolition-waste-protocol-0\\_en](https://ec.europa.eu/growth/content/eu-construction-and-demolition-waste-protocol-0_en)



*Machinery can support workers and improve safety, whilst new scanning techniques can help with material identification.*

- Separate at source at least hazardous and non-hazardous waste;
- Disassembly of buildings is constrained by the space available on site. Therefore, a balance should be struck on sorting as much as possible during the selective deconstruction phase and having the sorting infrastructure nearby.

### 3.6 Target group 6: Investors, developers and insurance providers

#### *Durability*

#### **30. Enhancing durability will decrease financial risk.**

*The importance of durability of products and materials should be promoted within the overall approach to buildings and products, and how this can be appropriately accounted for financially.*

#### **31. Life Cycle Costing should be promoted when preparing investment decisions.**

*The increased revenue streams that can be generated through reversible design should be integrated into the whole costing analysis.*

- Capitalise future risks of difficulty to deconstruct buildings and cost of waste management;
- Consider the residual value of buildings to help with savings in mortgages and money flows;
- The use of the ISO standard for DfD/A credits within GPP and sustainable building rating schemes provide an incentive to consider at this stage.

#### *Adaptability*

#### **32. Adaptability of buildings should be appropriately accounted for financially.**

*Any measure that is of benefit to the owner will minimise the risk of default.*

- Governments and building owners should consider the importance of adaptability within the overall approach to buildings and products, and how this can be appropriately accounted for financially.

#### *Reduce waste and facilitate high-quality waste management*

#### **33. The use of recycled and recyclable materials should be appropriately accounted for financially.**

*Finance/Insurance companies can set requirements for investing in projects.*

- Require or allow options for the use of recycled materials;
- Apply minimum standards for due diligence and determine and assess the circularity of the project.

### 3.7 Target group 7: Government / Regulators / Local authorities

On different levels, governments can affect preconditions for a circular construction sector through various incentives, policies, standards and regulations. They can notably:

- Regulate: through the enactment and implementation of legislation;
- Realise: by using mechanisms such as public procurement to drive change;
- Stimulate: by providing incentives and encouraging experimentation;
- Inspire: by providing leadership, vision and the dissemination of good practices.

#### **34. Adopt an integrated and holistic vision to provide a stable regulatory/legislative framework.**

- Ensure a holistic approach in measures: include reversibility and resource recovery and recycling next to other requirements such as energy efficiency;
- Stimulate the innovation and the development of new joining technologies that enable the reuse, recycling or recovery of components, without affecting the whole life impact of the building;

- Take a holistic approach and measure, or assess, the environmental performance over the whole life cycle (if not multiple life cycles) of the building and the building products, to ensure that legislative acts are not opposed to one another;
- Integrate circular economy principles in existing legislation and policy instruments wherever possible;
- Energy refurbishment of 3% of buildings owned by the national government required by the Energy Efficiency Directive (2012/27/EU amended by 2018/2002/EU) offers the opportunity to integrate resource efficiency and circularity aspects within the refurbishment requirements;
- Policy incentives that support sustainability and the internalisation of external cost could also provide support for the best design choices within a long-term vision;
- Encourage early-on 'risk-free' options, i.e., options without creating environmental or health hazards (according to the precautionary principle):
  - i. Distinguish between resources, materials/products and buildings;
  - ii. Integrate the use of bio-based materials in the approach.

### Regulate

#### **35. Decision-making and assessment tools are to be used actively during policy development.**

*This will also provide the tools to measure and assess if policies are to be implemented by the stakeholders affected.*

- Promote systematic data collection in a structural way that could be used for impact analysis. For instance, create a database and libraries that are freely accessible before moving to legal versions in harmony with the development of community regulation;
- Recognise relevant impact indicators for adaptability, deconstruction, reuse and recycling that can be integrated into building policies;
- Adopt a multi-life cycle approach (cradle-to-cradle) as an assessment tool to support the decision-making process, thus ensuring the holistic perspective of buildings, and quantifying all potential benefits from a circular model).

#### **36. Reinforce policies that promote reuse and high-quality recycling of buildings/building materials.**

- Limit landfilling to the necessary minimum, taking into account the iniquity of materials used in the past; provide for a responsible phase-out strategy;
- Promote selective deconstruction to enable removal and safe handling of hazardous substances;
- Facilitate reuse and high-quality recycling by selective removal of materials, and ensure the establishment of sorting systems for separate fractions of CDW;
- Promote the reduction of the content of hazardous substances and SVHC in materials and products;
- Promote repair activities;
- Aim for standardisation that can ensure the performance of products containing recycled materials;
- Implement new business models, such as EPR, to support the development of the secondary materials market;
- Encourage new business models to support products as a service;
- Promote the use of local recycling infrastructure, which should be sufficiently developed for each kind of construction waste and recovered products;
- Consider setting quantitative targets when developing policies;
- Integrate life cycle approaches in construction policies;
- Take into consideration the cross-border trade of re-used products (for example. through harmonisation of standards).

### Realise

#### **37. Use and promote the range of potential policy tools already available, especially GPP.**

- For any public works, use GPP with (i) innovative indicators and criteria, such as for buildings and maintenance, in the specifications and (ii) innovative procurement procedures that require reversible design





and deconstruction and high-quality recycling. Evaluate the project's environmental impact compared to less invasive alternatives;

- The BAMB Reversible Building Design tools are defining reversible design indicators that enable the assessment of the reuse potential and transformation capacity of existing buildings, as well as of new building designs. These indicators could be used for public procurement as well as to define building permit criteria and assessment;
- Use life cycle assessment approaches to incentivise overall performance increases;
- Government and building owners can specify, in the tenders and proposals, the use of sustainable building rating schemes such as the ISO standard for DfD/A and Level(s) providing a robust approach to DfD.

### *Stimulate*

#### **38. Promote the adaptability of buildings.**

- Publish guidance documents that promote adaptability –building owners and finance/insurance companies will follow accordingly;
- Promote the multiple use of buildings, so construct buildings with suitable dismantlable internal partition, etc., and provide incentives for that purpose;
- Adaptability can be promoted at different scales<sup>14</sup>: component, building and neighbourhood level:
  - i. Adaptability at component level (reversibility, independence of layers, compatibility, etc.) should be promoted to stimulate reuse of components and materials and make maintenance and refurbishment easier;
  - ii. Adaptability at building level (extensibility, versatility, accessibility of layers, etc.) should be promoted to make a building more future proof and ready for new needs and different uses;
  - iii. Adaptability at neighbourhood level should be promoted to maintain good social cohesion and flexible infrastructure that meet the demands of changing societal needs.

#### **39. Ensure long-term quality of buildings.**

- Enable governments and owners of buildings and infrastructure to consider the importance of recyclability within the overall approach to buildings and products, and how to account financially for this appropriately.;
- Re-use awareness will be achieved by whole (and even multiple) life costing carried out in conjunction with environmental assessment beyond the building life cycle;
- Prohibit planned obsolescence, and mitigate obsolescence / ensure mastery of products' lifespans through technological development.

#### **40. Provide incentives for the development of design principles for circular and sustainable buildings.**

- For instance, by planning for end of life at the design stage, requiring separate targets on the design of buildings, which have a minimum level of reusable components, measured using reversible building design indicators, and combined with separate targets on reuse, recycling, recovery at end of life. The more buildings that are designed in this way, the larger the pool of future resources will be;
- Reversible products might use more resources at the start (due to more robust design, for example), but make it possible to recover the resources but also reuse the product in multiple life cycles;
- Stimulate innovation in circular materials, circular design and production facilities.

---

<sup>14</sup> Framework 'design for change' developed in a research project of OVAM commissioned by the Flemish government (Environment, Nature and Energy Department), conducted by a consortium of Unit Smart Energy and Built Environment (VITO), TRANSFORM Research team (Vrije Universiteit Brussel) and ASRO (KU Leuven) (<https://www.ovam.be/sites/default/files/atoms/files/TWOL-Design-for-change.pdf>)



*Inspire*

**41. Develop or stimulate building actors to develop integrated design and decision-making guidelines and tools that take into account long-term impacts.**

- Promote their use in building rating schemes – thus encouraging their use in the design. Key standards to consider/promote for the design process are, amongst others:
  - i. EN and ISO standards for building structures;
  - ii. Whole-building LCA (EN15978);
  - iii. Level(s);
  - iv. Reversible Building Design protocol/tool (RBD)<sup>15</sup>;
  - v. Cost-benefit analysis;
  - vi. ISO standards for DfD/A (ISO 20887);
  - vii. Role of BIM.

**42. Adopt a long term vision integrating multiple-use and life cycles to support an effective approach to reducing the use of natural resources.**

- Promote the multiple-use design of buildings – aim for reuse and/or renovation of buildings (repurposing), and promoting the multi-functionality of buildings over time;
- Stimulate scenario-thinking during the pre-design phase (with the architect and the building owner/client) to get insights into the different possible uses of the building over time;
- Create awareness about the fact that reversible products might use more resources at the start, but make it possible to recover resources and also reuse the product in multiple life cycles.

---

<sup>15</sup> Developed under the project BAMB, <https://www.bamb2020.eu/wp-content/uploads/2018/12/Reversible-Building-Design-guidelines-and-protocol.pdf>

## Annex 1 – References

BAMB - Buildings As Material Banks, available at <https://www.bamb2020.eu/>

European Commission, *EU Construction & Demolition Waste Management Protocol*, September 2016, available at: [http://ec.europa.eu/growth/content/eu-construction-and-demolition-waste-protocol-0\\_en](http://ec.europa.eu/growth/content/eu-construction-and-demolition-waste-protocol-0_en) .

European Commission, *Annex: Accelerating Clean Energy in Buildings (Annex to the Communication from the Commission to the European Parliament, the Council, the European Economic and Social Committee, the Committee of the Regions and the European Investment Bank - Clean Energy for all Europeans*, COM(2016) 860 final, Brussels, 30.11.2016, available at [https://eur-lex.europa.eu/resource.html?uri=cellar:fa6ea15b-b7b0-11e6-9e3c-01aa75ed71a1.0001.02/DOC\\_2&format=PDF](https://eur-lex.europa.eu/resource.html?uri=cellar:fa6ea15b-b7b0-11e6-9e3c-01aa75ed71a1.0001.02/DOC_2&format=PDF)

Johnson J, *The Concrete Initiative - Closing The Loop: What Type of Concrete Re-Use Is the Most Sustainable Option?*, Theconcreteinitiative.eu, 2016, available at <https://www.theconcreteinitiative.eu/newsroom/publications/165-closing-the-loop-what-type-of-concrete-re-use-is-the-most-sustainable-option>

Norwegian building authority, *Norwegian Regulations on technical requirements for construction works (Forskrift om tekniske krav til byggverk (Byggteknisk forskrift - TEK17)*, July 2017, available at <https://dibk.no/globalassets/byggeregler/regulation-on-technical-requirements-for-construction-works--technical-regulations.pdf>

*Steel And The Circular Economy - Design for Deconstruction and Reuse*, Steelconstruction.info [https://www.steelconstruction.info/Steel\\_and\\_the\\_circular\\_economy#Design\\_for\\_deconstruction\\_and\\_reuse](https://www.steelconstruction.info/Steel_and_the_circular_economy#Design_for_deconstruction_and_reuse)

*Steel Construction Products*, Steelconstruction.info, available at: [https://www.steelconstruction.info/Steel\\_construction\\_products#Fasteners\\_and\\_fixings](https://www.steelconstruction.info/Steel_construction_products#Fasteners_and_fixings)

The Norwegian Environmental Product Declaration (EPD) Foundation, *Norwegian EPD programme - The Norwegian adaptation of the ISO 14025 Type III environmental declaration*, available at <https://www.epd-norge.no/getfile.php/134699-1478769108/Dokumenter/Dokumenter%20godkjente%20verifikatorer/The%20Norwegian%20EPD-programme%20-main%20document%20rev17042014%20m%20vedlegg.pdf>

*Framework 'design for change'* developed in a research project of OVAM commissioned by the Flemish government (Environment, Nature and Energy Department), conducted by a consortium of Unit Smart Energy and Built Environment (VITO), TRANSFORM Research team (Vrije Universiteit Brussel) and ASRO (KU Leuven) (<https://www.ovam.be/sites/default/files/atoms/files/TWOL-Design-for-change.pdf>)

*Level(s) - Building sustainability performance*, available at <http://ec.europa.eu/environment/eusss/buildings.htm>

*BAZED*, available at [www.bazed.fr](http://www.bazed.fr) . The BAZED project proposes a design approach for the prevention of waste, tools and the feedback of experiences through one or more lines of action: conservation of the existing, eco-design, dismantling, etc.

These approaches are broken down according to the different players in the construction industry: project owners, prime contractors and companies.



## Annex 2 – Terms and definitions

### **Adaptability**

Possibility to change or modify a product, system or module to make it suitable for a particular purpose.

[SOURCE: ISO 6707-1:2017, 3.7.3.79, <https://www.iso.org/obp/ui/fr/#iso:std:iso:6707:-1:ed-5:v1:en>]

### **Assembly**

Set of related components attached to each other.

[SOURCE: ISO 6707-1:2017, 3.3.5.5, <https://www.iso.org/obp/ui/fr/#iso:std:iso:6707:-1:ed-5:v1:en>]

### **Assembly sequences**

The sequences in assembly create dependencies between building elements, by locking elements together. The way we assemble a building sets the mirror image of the building during its disassembly and transformation phase. Two major assembly/disassembly sequences can be distinguished: a parallel sequence and a sequential sequence.

[SOURCE: Reversible Building Design Tools (WP3), BAMB Reversible Building Design Guidelines (synthesis of D10, 3/2018), <http://www.bamb2020.eu/wp-content/uploads/2018/12/Reversible-Building-Design-guidelines-and-protocol.pdf>]

### **Base element**

A building product (system/component/element) is a carrier of a specific building's functions. Each assembled product represents a cluster of elements that are carriers of sub-functions. To provide independence for elements within two clusters, each cluster should define its base element, which integrates all surrounding elements of that cluster. This element functions as intermediary between elements as well as between clusters. Such an intermediary share element functions on two levels: (i) it connects elements within the cluster and (ii) performs as an intermediary with other clusters. Base elements/intermediaries can be found at all levels of technical composition of a building (see figure below).



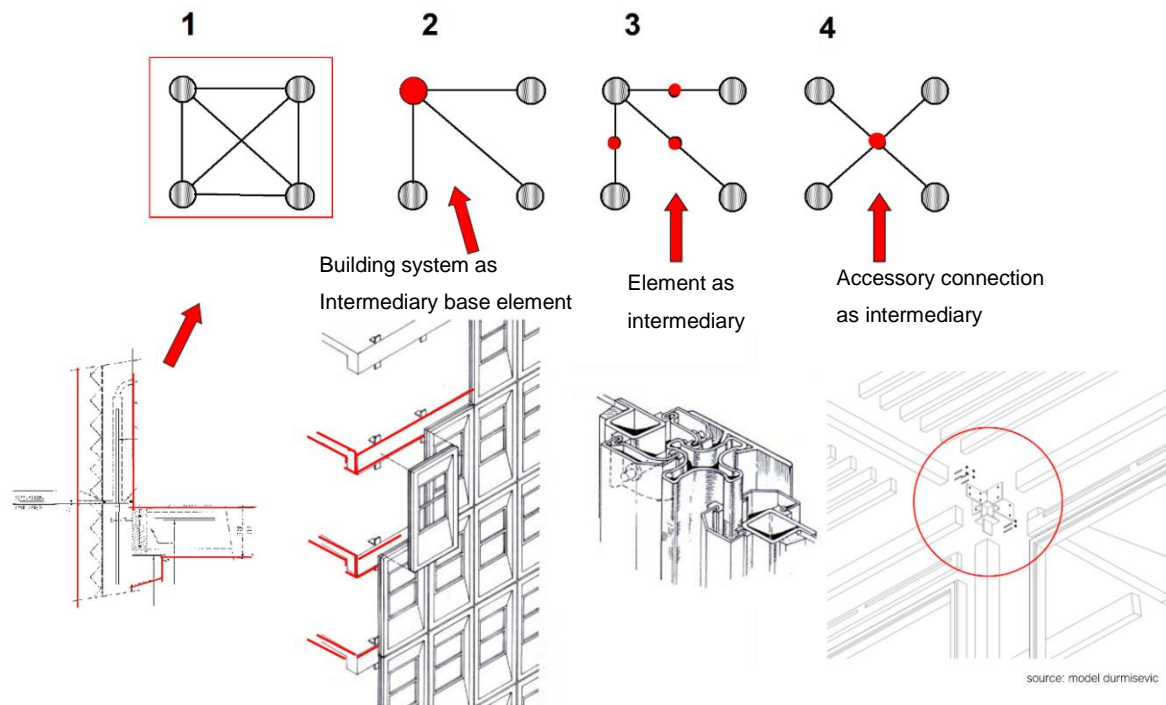

[SOURCE: Dr. Elma Durmisevic - H2020 project Buildings As Material Banks (BAMB), <https://www.bamb2020.eu/wp-content/uploads/2018/12/Reversible-Building-Design-guidelines-and-protocol.pdf> ]

### Building

Construction works that provide shelter for its occupants or contents as one of its main purposes, are usually partially or totally enclosed and designed to stay in one place permanently.

[SOURCE: ISO 6707-1:2017, 3.1.1.3, <https://www.iso.org/obp/ui/fr/#iso:std:iso:6707:-1:ed-5:v1:en>]

### Circular economy

An economy where the value of products, materials and resources is maintained in the economy for as long as possible, and the generation of waste minimised.

[SOURCE: EC. 2015. Closing the loop - An EU action plan for the Circular Economy. COM(2015)614 final. Brussels, 2.12.2015, <https://ec.europa.eu/transparency/regdoc/rep/1/2015/EN/1-2015-614-EN-F1-1.PDF>]

### Component

Product manufactured as a distinct unit to serve a specific function or functions.

[SOURCE: ISO 6707-1:2014, 6.1.3, <https://www.iso.org/obp/ui/#iso:std:iso:6707:-1:ed-4:v1:en>]

### Construction works

Everything that is constructed or results from construction operations. [SOURCE: ISO 6707-1:2017, 3.1.1.1]

Buildings and civil engineering works.

[SOURCE: Regulation (EU) No 305/2011 of the European Parliament and of the Council of 9 March 2011 laying down harmonised conditions for the marketing of construction products and repealing Council Directive 89/106/EEC, Article 2, <https://eur-lex.europa.eu/legal-content/EN/TXT/?uri=celex%3A32011R0305>]

### Construction and demolition waste

Waste generated by construction and demolition activities.

[SOURCE: Directive (EU) 2018/851 of the European Parliament and of the Council of 30 May 2018 amending Directive 2008/98/EC on waste, Article 3, [https://eur-lex.europa.eu/legal-content/EN/TXT/?uri=uriserv:OJ.L\\_.2018.150.01.0109.01.ENG](https://eur-lex.europa.eu/legal-content/EN/TXT/?uri=uriserv:OJ.L_.2018.150.01.0109.01.ENG)]

**Deconstruction**

Process to address the end-of-life of a structure (building, infrastructure, etc.) including the analysis of its contents (audit, assessment and project), securing the current construction (technically and environmentally), the decontamination and removal of any hazardous waste existing, plus the demolition activities to enable the desired change and the recycling operations to recover the value of the existing materials.

[SOURCE: Stakeholders of the Construction 2020 Target Group 3]

**Demolition**

Removal by destructive methods.

**Disassembly**

Non-destructive taking apart of a construction works or constructed asset into constituent materials or components.

[SOURCE: ISO/FDIS 15392, 3.11, <https://www.iso.org/obp/ui/#iso:std:iso:15392:ed-2:v1:en>]

**Design for deconstruction**

Approach to the design of a product or structure that facilitates deconstruction at the end of its useful life, in such a way that components and parts can be reused, recycled or recovered for further economic use or, in some other way, diverted from the waste stream.



### **Downcycling**

A process in which the material's quality, potential for future reuse, and economic value decreases during the conversion process.

[SOURCE: (Based on) Deconstruction and Materials Reuse – an International Overview, CIB Publication 300, Final Report of Task Group 39 on Deconstruction Edited by Abdol R. Chini, University of Florida, <https://www.irbnet.de/daten/iconda/CIB1303.pdf>]

### **Durability**

A constructed asset or any of its components, that makes it perform its required functions in its service environment over a specific period without unforeseen maintenance or repair.

[SOURCE: ISO 17738-1:2017, 3.6, <https://www.iso.org/obp/ui/#iso:std:iso:17738:-1:ed-1:v1:en>]

### **Extended producer responsibility scheme**

Set of measures taken by Member states to ensure that producers of products bear financial responsibility or financial and organisational responsibility for the management of the waste stage of a product's life cycle.

[SOURCE: Directive (EU) 2018/851 of the European Parliament and of the Council of 30 May 2018 amending Directive 2008/98/EC on waste, Article 3, [https://eur-lex.europa.eu/legal-content/EN/TXT/?uri=uriserv:OJ.L\\_.2018.150.01.0109.01.ENG](https://eur-lex.europa.eu/legal-content/EN/TXT/?uri=uriserv:OJ.L_.2018.150.01.0109.01.ENG)]

## Functional decomposition

Functional decomposition defines the level of integration of functions within elements and the dependence of functions. It embraces the functional separation and the functional autonomy.

Functional autonomy defines the dependency between independent functions of an element (e.g. structure, finishing, technical elements, piping, etc.) by planned or unplanned interpenetration of components having different functions.

This means that relocation or resizing of components that have one function influences the integrity of other components that have other functions.

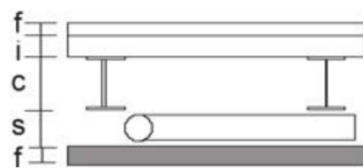
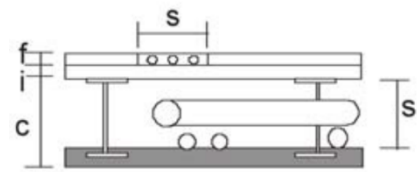

Functions within a floor system  
 C-structure  
 F-finishing  
 S-servicing  
 I-isolating

| Assessment functional autonomy                     |     |
|--|-----|
| 1.total separation (modular zoning)                | 1,0 |
| 2.planned interpenetration for different solutions | 0,8 |
| 3.planned interpenetration for one solution        | 0,4 |
| 4.unplanned interpenetration                       | 0,2 |
| 5.total integration                                | 0,1 |

source: model durmisevic

[SOURCE: Dr. Elma Durmisevic - H2020 project Buildings As Material Banks (BAMB), <https://www.bamb2020.eu/wp-content/uploads/2018/12/Reversible-Building-Design-guidelines-and-protocol.pdf> ]



### Geometry of the connections

The geometry of the connections refers to the geometry of the product edge and the standardization of the connections, which will affect the ease of disassembly as well as the assembly sequence.

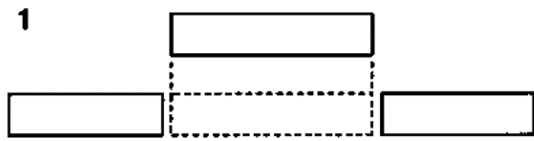

1  
Open - linear geometry

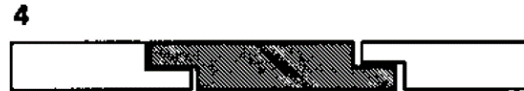

4  
unsymmetric overlapping



2  
symmetric overlapping



5  
closed - integral on one side

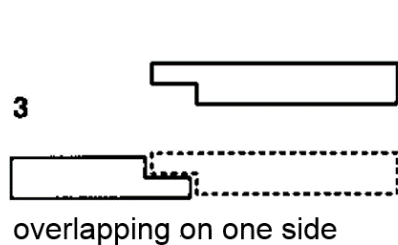

3  
overlapping on one side



6  
closed - integral on two side

[SOURCE: Dr. Elma Durmisevic - H2020 project Buildings As Material Banks (BAMB), <https://www.bamb2020.eu/wp-content/uploads/2018/12/Reversible-Building-Design-guidelines-and-protocol.pdf> ]

### Hazardous waste

Waste that displays one or more of the hazardous properties listed in Annex III of the Directive 2008/98/EC of the European Parliament and of the Council of 19 November 2008 on waste and repealing certain Directives.

[SOURCE: Directive 2008/98/EC of the European Parliament and of the Council of 19 November 2008 on waste and repealing certain Directives, <https://eur-lex.europa.eu/legal-content/EN/TXT/?uri=celex%3A32008L0098>]



### Hierarchical relations between elements

The type of relations between individual elements within a building has a significant impact on the disassembly potential of a structure.

The number of links between the different elements, as well as how the different clusters or functions connect to each other, will have an impact on the ease of disassembly.

When the relations (read connections) between different clusters of functions or sub-assemblies is limited to the relation with the base element of this sub-assembly, the disassembly of the different sub-assemblies will be facilitated as well as the adaptation within one sub-assembly (assembly C in the image below).

When relations are made between the different elements (other than the base element) of different sub-assemblies, the disassembly and adaptations will be more elaborate (assembly A and B in the image below).

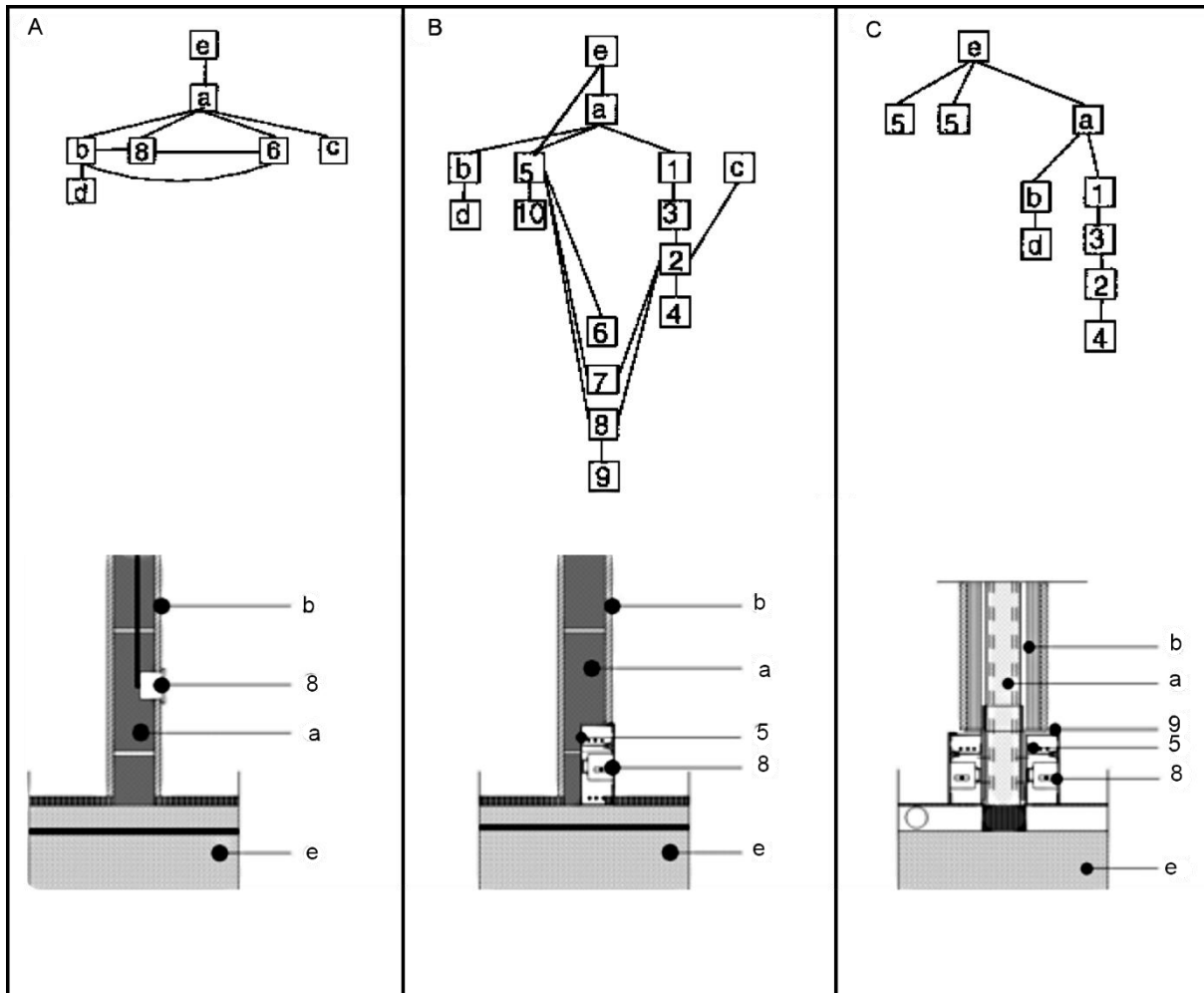

[SOURCE: Dr. Elma Durmisevic - H2020 project Buildings As Material Banks (BAMB), <https://www.bamb2020.eu/wp-content/uploads/2018/12/Reversible-Building-Design-guidelines-and-protocol.pdf>]

### Level(s)

A voluntary reporting framework to improve the sustainability of buildings. Using existing standards, Level(s) provides a common EU approach to the assessment of environmental performance in the built environment.

[SOURCE: Building sustainability performance - Level(s), EC DG ENV, <https://ec.europa.eu/environment/eussd/buildings.htm>]

### **Life cycle assessment**

Compilation and evaluation of the inputs, outputs and the potential environmental impacts of a product system throughout its life cycle.

[SOURCE: ISO 14040:2006, 3.2, <https://www.iso.org/obp/ui/#iso:std:iso:14040:ed-2:v1:en>]

### **Life cycle co-ordination in assembly/disassembly**

Co-ordination of elements, with those that have a long life cycle and greatest dependencies in assembly, should be assembled first and disassembled last taking into account use, technical and size aspects.

[SOURCE: Dr. Elma Durmisevic, Reversible Building design guidelines, BAMB Project, <https://www.bamb2020.eu/wp-content/uploads/2018/12/Reversible-Building-Design-guidelines-and-protocol.pdf>]

### **Life cycle costing**

Methodology for systematic economic evaluation of life cycle costs over a period of analysis, as defined in the agreed scope.

[SOURCE: ISO 15686-5:2017, 3.1.8, <https://www.iso.org/obp/ui/#iso:std:iso:15686:-5:ed-2:v1:en>]

### **Manufacturer**

Any natural or legal person who manufactures a construction product or who has such a product designed or manufactured, and markets that product under his name or trademark.

[SOURCE: Regulation (EU) No 305/2011 of the European Parliament and of the Council of 9 March 2011 laying down harmonised conditions for the marketing of construction products and repealing Council Directive 89/106/EEC, Article 2, <https://eur-lex.europa.eu/legal-content/EN/TXT/?uri=celex%3A32011R0305>]

### **Modular**

Composed of modules for easy construction or arrangement and adaptation or disassembly.

[SOURCE: (Based on) ISO 7176-26:2007, 4.8.11, <https://www.iso.org/obp/ui/#iso:std:iso:7176:-26:ed-1:v1:en>]

### **Module**

Set of standardised parts or independent units.

### **Obsolescence**

Loss of ability of an item to perform satisfactorily due to changes in performance requirements.

[SOURCE: ISO 15686-1:2011, 3.14, <https://www.iso.org/obp/ui/#iso:std:iso:15686:-1:ed-2:v1:en>]

### **Pre-demolition audit**

The demolition contractor carries out an advanced inspection of the demolition project and an inventory of the materials (hazardous and non-hazardous) to get insight into the nature, quantity and any contamination of the extracted demolition materials. An inventory is made of the risks to occupational safety and safety risks to the surroundings.

[SOURCE: EU Construction & Demolition Waste Management Protocol, <https://ec.europa.eu/docsroom/documents/20509/attachments/1/translations/en/renditions/native>]

### **Pre-development audit**

Pre-development audits include demolition and refurbishment assessments of what can be reused from deconstruction and stripped out, respectively. These should also inform the potential to reuse products and materials in subsequent construction and/or fit out (of refurbishment).

[SOURCE: Reuse of building products and materials – barriers and opportunities, Gilli Hobbs, Katherine Adams BRE, Watford, United Kingdom, June 2017, <https://www.bamb2020.eu/wp-content/uploads/2017/07/Reuse-of-building-products-and-materials-barriers-and-opportunities.pdf>]



### **Prevention**

Measures taken before a substance, material or product has become waste that reduces:

- (a) the quantity of waste, including through the reuse of products or the extension of the life span of products;
- (b) the adverse impacts of the generated waste on the environment and human health; or
- (c) the content of hazardous substances in materials and products.

[SOURCE: Directive 2008/98/EC of the European Parliament and of the Council of 19 November 2008 on waste and repealing certain Directives, <https://eur-lex.europa.eu/legal-content/EN/TXT/?uri=celex%3A32008L0098> ]

### **Recovery**

Any operation, the principal result of which, is waste serving a useful purpose by replacing other materials which would otherwise have been used to fulfil a particular function, or waste being prepared to fulfil that function, in the plant or in the wider economy. Annex II sets out a non-exhaustive list of recovery operations.

[SOURCE: Directive 2008/98/EC of the European Parliament and of the Council of 19 November 2008 on waste and repealing certain Directives, <https://eur-lex.europa.eu/legal-content/EN/TXT/?uri=celex%3A32008L0098>]

### **Recycling**

Any recovery operation, by which waste materials are reprocessed into products, materials or substances, whether for the original or other purposes. It includes the reprocessing of organic material but does not include energy recovery and the reprocessing into materials that are to be used as fuels or for backfilling operations.

[SOURCE: Directive 2008/98/EC of the European Parliament and of the Council of 19 November 2008 on waste and repealing certain Directives, <https://eur-lex.europa.eu/legal-content/EN/TXT/?uri=celex%3A32008L0098>]

### **Recyclable**

Characteristic of a product or associated component, that can be diverted from the waste stream through available processes and programmes, and can be collected, processed and returned to use in the form of raw materials or products.

[SOURCE: ISO 14021:2017, 7.7.1, <https://www.iso.org/obp/ui/#iso:std:iso:14021:ed-2:v1:en:sec:7.7.1>]

### **Refurbishment**

Modification and improvements to an existing building or civil engineering works in order to bring it up to an acceptable condition.

[SOURCE: ISO 6707-1:2017, 3.5.1.45, <https://www.iso.org/obp/ui/#iso:std:iso:6707:-1:ed-5:v1:en>]

### **Remanufacturing**

Remanufacturing is the process of returning a used product to, at least, its original performance with a warranty that is equivalent to or better than that of the newly manufactured product.

[SOURCE: European Remanufacturing Network, Funded by the Horizon 2020 Framework Programme of the European Union, <https://www.remanufacturing.eu/about-remanufacturing.php>]

### **Repair**

Returning a product, component, assembly or system to an acceptable condition by renewal or replacement of worn, damaged, or degraded parts.

[SOURCE: ISO 6707-1:2017, 3.1.5.4, <https://www.iso.org/standard/72244.html>]

### **Replacement**

Change of parts of an existing item to regain its functionality.



## Repurposing

Using an obsolete item considered by its owner as a waste, with another use totally different from the initial one.

[SOURCE: Structures and Architecture: New concepts, applications and challenges, How to build the future with limited and finite resources, Paulo J. Cruz, Y. Sieffert & D. Daudon, J-M Huygen, 2013, <https://www.taylorfrancis.com/books/e/9780429159350>]

## Reusability

Ability of a material, product, component or system to be used in its original form more than once and maintain its value and functional qualities during recovery to accommodate reapplication for the same or any purpose.

[SOURCE: (Based on) Level(s) – A common EU framework of core sustainability indicators for office and residential buildings, Part 3: How to make performance assessments using Level(s), Macro-objective 2 <https://ec.europa.eu/jrc/en/publication/levels-common-eu-framework-core-sustainability-indicators-office-and-residential-buildings-part-3>]

## Reuse

Any operation by which products or components that are not waste are used again for the same purpose for which they were conceived.

[SOURCE: Directive 2008/98/EC of the European Parliament and of the Council of 19 November 2008 on waste and repealing certain Directives, <https://eur-lex.europa.eu/legal-content/EN/TXT/?uri=celex%3A32008L0098>]

### Selective demolition

Removal of materials from a demolition site in a pre-defined sequence in order to maximize recovery and recycling performance.

[SOURCE: (Based on) Level(s) – A common EU framework of core sustainability indicators for office and residential buildings, Part 3: How to make performance assessments using Level(s), Macro-objective 2 <https://ec.europa.eu/jrc/en/publication/levels-common-eu-framework-core-sustainability-indicators-office-and-residential-buildings-part-3>]

## Systemization

Systematization refers to the grouping of sub-systems and the constituent components in a building to encourage open/independent strands of construction/layers; includes structure and material levels and clustering aiming to limit the number of disassembly sequences.

[SOURCE: Testing BAMB results through pilots and prototyping (WP4), BAMB pilots – “4 Pilots built + Feedback report” (D14, 2/2019), <https://www.bamb2020.eu/wp-content/uploads/2019/03/20190228-BAMB-D14.pdf>]

## Upcycling

A process in which the material's quality, potential for future reuse, and economic value is increased during the conversion process.

[SOURCE: Deconstruction and Materials Reuse – an International Overview, CIB Publication 300, Final Report of Task Group 39 on Deconstruction Edited by Abdol R. Chini, University of Florida, <https://www.irbnet.de/daten/iconda/CIB1303.pdf>]

## Type of connections

The type of connection refers to the way in which elements are connected to each other using, for example, dry or wet connections, as well as the type of these connections and the (planned) design.

[SOURCE: Reversible Building Design Tools (WP3), BAMB Reversible Building Design Guidelines (synthesis of D10, 3/2018), <http://www.bamb2020.eu/wp-content/uploads/2018/12/Reversible-Building-Design-guidelines-and-protocol.pdf> ]

## Waste management



The collection, transport, recovery and disposal of waste, including the supervision of such operations and the after-care of disposal sites, and including actions taken as a dealer or broker.

[SOURCE: Directive 2008/98/EC of the European Parliament and of the Council of 19 November 2008 on waste and repealing certain Directives, <https://eur-lex.europa.eu/legal-content/EN/TXT/?uri=celex%3A32008L0098> ]